

LED FLOOD LIGHT

WARRANTY

1. 5-year warranty replacement warranty will be provided during the warranty period if the lamp suffers quality problems.
2. During the warranty period, the customer shall return the damaged goods or failed parts for inspection and repair by Goldenlux. Goldenlux will then send the fixed or new parts back.
3. A replacement warranty will be provided once valid documents are presented.

The following circumstances will not receive replacement warranty:

- ① Damage caused, including, but not limited to, damage from abnormal working conditions, improper usage, storage that does not conform to the instruction manual;
- ② Dismantling, modification or improper installation or repairing of the products without Goldenlux's authorization;
- ③ Damages caused by environmental circumstances including, but not limited to, fire, flood, lighting strike, earthquake.

WARNING

To avoid the risk of fire, explosion, or electric shock :

This product should be installed, inspected, and maintained by a qualified electrician only, in accordance with all applicable electrical codes. Verify that the power wire is installed correctly following the guidelines set forth by the applicable electrical codes.

To avoid electric shock:

- Be certain electrical power is OFF before and during installation and maintenance.
- Luminaires must be supplied by a wiring system suitable per local code with an equipment grounding conductor.

To avoid burning hands:

- Before performing maintenance, ensure Luminaire is allowed to cool after powering off for a period of 10 minutes.

To avoid product degradation:

- Do not operate in ambient temperatures above those indicated on the luminaire date sheet.
- Use proper supply wiring as specified on the luminaire data sheet.
- Avoid use in environments containing sulfur, chlorine or other halides, methyl acetate or ethyl acetate, cyanoacrylates, glycol ethers, formaldehyde, or butadiene.
- Mount luminaire no less than 36 inches from the ceiling.
- Make sure the supply voltage is within the voltage range stated on the date sheet.
- Use only replacement parts from Goldenlux.
- Aircraft cable mounting is recommended for dry locations only.
- Use only Goldenlux or equivalent parts for mounting luminaire.

MOUNTING

PENDANT EYEBOLT MOUNTING

STEP 1

Drill hole on the wall.



STEP 2

Put the expansion screw into the wall.

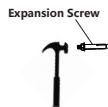

STEP 3

Fasten the lamp on the wall.

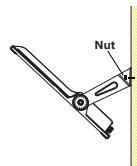

STEP 4

Wire according to the diagram.

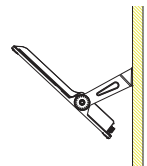

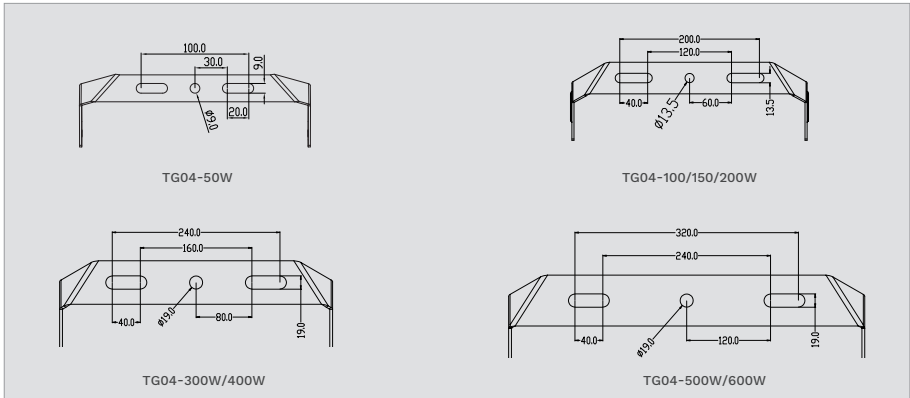

CEILING MOUNTING:

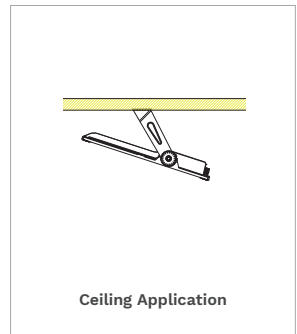
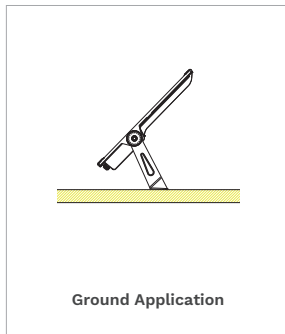
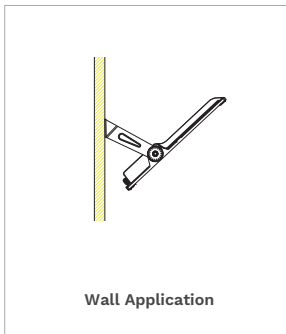

REFER TO THE WIRING DIAGRAM TO MAKE ELECTRICAL CONNECTIONS

